

FLEXmax 30/40 Series

Charge Controller

User's Manual



About OutBack Power Technologies

OutBack Power Technologies is a leader in advanced energy conversion technology. Our products include true sine wave inverters/chargers, maximum power point tracking charge controllers, and system communication components, as well as circuit breakers, accessories, and assembled systems.

Contact Information

Address: Outback Power - Europe
Hansastraße 8
D-91126
Schwabach, Germany

Phone: +49 (0)9122 79889-0
+49 (0)9122 79889-21 (Fax)

Email: Support@outbackpower.com

Website: <http://www.outbackpower.com>

Disclaimer

UNLESS SPECIFICALLY AGREED TO IN WRITING, OUTBACK POWER TECHNOLOGIES:

(a) MAKES NO WARRANTY AS TO THE ACCURACY, SUFFICIENCY OR SUITABILITY OF ANY TECHNICAL OR OTHER INFORMATION PROVIDED IN ITS MANUALS OR OTHER DOCUMENTATION.

(b) ASSUMES NO RESPONSIBILITY OR LIABILITY FOR LOSS OR DAMAGE, WHETHER DIRECT, INDIRECT, CONSEQUENTIAL OR INCIDENTAL, WHICH MIGHT ARISE OUT OF THE USE OF SUCH INFORMATION. THE USE OF ANY SUCH INFORMATION WILL BE ENTIRELY AT THE USER'S RISK.

Notice of Copyright

FLEXmax 30/40 Series Charge Controller Owner's Manual © January 2016 by OutBack Power Technologies. All Rights Reserved.

Trademark

OutBack Power and the OutBack Power logo are trademarks owned and used by OutBack Power Technologies, Inc. The ALPHA logo and phrase "member of the Alpha Group" are trademarks owned and used by Alpha Technologies Inc. These trademarks may be registered in the United States and other countries.

Effective Date

January 2016
(1/2016)

Table of Contents

Important Safety Information.	5
Safety Symbols	5
General Safety Information	5
General Information.	6
Overview	6
Features	6
Optional Accessories	8
Maximum Power Point Tracking Technology	8
Installation Instructions	9
General Installation Notes	9
PV Array Requirements	10
Wire Size	12
Operation 15	
MPPT Technology	15
Battery Charging Information	17
LED Indicators	20
Configuring the Controller	21
Load Set Mode	22
Protection, Troubleshooting and Maintenance.	24
Protection	24
Troubleshooting	26
Maintenance	27
Technical Specifications	28
Electrical Parameters	28
Control Parameters	29
Environmental Parameters	30
Mechanical Parameters	30

Figures

Fig. 2-1, FLEXmax 30/40 Overview	7
Fig. 3-1, Installation Overview	14
Fig. 4-1, Comparison to Traditional Controllers	16
Fig. 4-2, MPPT Charging Algorithm	17
Fig. 4-3, LED Indicators	20
Fig. 4-4, Setting Operation.	21
Fig. 4-5, RJ45 Defined Pins.	22
Fig. 4-6, Light On/Off	23
Fig. 4-7, Light On+ Timer.	23
Fig. 6-1, FLEXmax 30 12V Conversion Efficiency Curves	31
Fig. 6-2, FLEXmax 30 24V Conversion Efficiency Curves	31
Fig. 6-3, FLEXmax 40 12V Conversion Efficiency Curves	32
Fig. 6-4, FLEXmax 40 24V Conversion Efficiency Curves	32
Fig. 6-5, FLEXmax 30 Dimensions	33
Fig. 6-6, FLEXmax 40 Dimensions	34

Tables

Table 3-1	10
Table 3-2	11
Table 3-3	12
Table 3-4	13
Table 4-1	20
Table 5-1	26
Table 6-1	28
Table 6-2	29
Table 6-3	30
Table 6-4	30

Safety Symbols

This manual contains important safety, installation and operating instructions for the FLEXmax 30/40 Series Charge Controller. The following symbols are used throughout this manual to indicate potentially dangerous conditions or mark important safety instructions.

**WARNING:**

Indicates a potentially dangerous condition. Use extreme caution when performing this task.

**CAUTION:**

Indicates a critical procedure for safe and proper operation of the controller.

**NOTE:**

Indicates a procedure or function that is important for the safe and proper operation of the controller.

General Safety Information

- » Read all of the instructions and warnings in the manual before beginning installation.
- » There are no user-serviceable parts inside the FLEXmax 30/40 Series. Do not disassemble or attempt to repair the controller.
- » Disconnect the solar module and fuses/breakers near the battery before installing or adjusting the FLEXmax 30/40 Series Controller.
- » Install external fuses/breakers as required.
- » Mount the controller indoors.
- » Do not allow water to enter the controller.
- » Install the controller in well ventilated places, the controller's heat sink may become very hot during operation.
- » Confirm that power connections are tightened to avoid excessive heating from loose connections.

General Information

Overview

Thank you for selecting the FLEXmax 30/40 Series Charge Controller.

Features

- » 12V/24V automatically identified or user-defined working voltage.
- » Cast aluminum chassis provides excellent heat dissipation.
- » Advanced maximum power point tracking technology optimizes the PV system, providing peak conversion efficiency as high as 98%.
- » The controller provides the industry's highest tracking efficiency of 99%.
- » Widely used with automatic recognition during the day or at night.
- » Several load methods are supported for different demands.
- » Supports multiple load control modes: manual, light (on/off), light (on/off/timer), and time-controlled.
- » Supports 4 charging options: Sealed, Gel, Flooded and User-defined.
- » The FLEXmax 30/40 Series compensates for temperature and corrects the charging and discharging parameters automatically, improving the battery life.
- » The FLEXmax 30/40 Series offers protection from high temperatures, over charging, PV and load short, PV (battery) reversed, and over current.
- » Actual power and record function provides the convenience to check the date every day, every month and every year.
- » RS-485 ports via the open standard Modbus protocol are supported to meet several different demands.
- » With supporting PC monitoring software and remote meter Mate Micro, it is convenient to check the real-time data of controllers as well as set parameters.
- » Supports firmware update.

The FLEXmax 30/40 charge controller charges and discharges the batteries in off grid solar applications. The smart tracking algorithm of the controller maximizes PV cell energy returns. A low voltage disconnect function (LVD) prevents the battery from over discharging. The FLEXmax 30/40 charging process optimizes battery life and improves overall system performance. The self diagnostic and electronic protection features minimize possible damage from installation mistakes or system faults. The FLEXmax 30/40 RJ45 interfaces can communicate with other system components.

Read and understand this manual to take advantage of the FLEXmax 30/40's best features and components. This will help optimize the functions and improve the solar PV system.

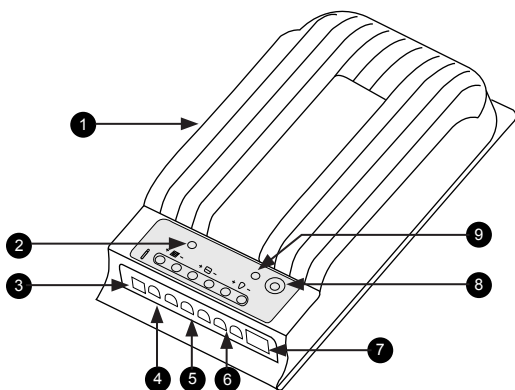

Fig. 2-1, FLEXmax 30/40 Overview

FLEXmax Series Components			
Number	Name	Number	Name
1	Heat Sink	6	Load Terminal
2	PV - Indicator	7	RS-485 Port**
3	RTS Port*	8	Load Indicator Load Button (Disconnect)
4	Solar Terminal	9	Battery LED Indicator
5	Battery Terminal		

*Connection for an RTS cable (Remote Temperature Sensor cable) for remote detection of battery temperature.

**An RJ-485 Port that allows a PC connection to monitor the controller and update firmware.

General Information

Optional Accessories

1. Remote Temperature Sensor (Model: RTS Micro)

Acquires the battery temperature to undertake temperature compensation and control parameters. The standard cable length is 3m (length can be customized). The RTS micro connects to port number 3 on the controller (See Fig. 2-1).



NOTE

Unplugging the RTS will set the battery temperature to a fixed value of 25 °C

2. Remote Meter (Model: Mate Micro)

The digital remote meter displays system operating information, error indications, and self-diagnostics. Information is displayed on a backlit LCD display that is easy to read, with large buttons allowing easy navigation through the meter menus. The meter can be flush mounted in a wall or frame. The Mate Micro (standard edition) is supplied with a 2 meter long cable. The Mate Micro connects the FLEXmax 30/40 series with the RJ45 interface.

3. USB to RS-485 Converter (Model: FM Micro Comm Cable)

The USB to RS-485 converter is used to monitor each controller on the network using the OB Micro Series PC software to update the firmware. The length of cable is 1.5m. The FM Micro Comm Cable connects to the RS-485 to port number 7 on the controller (See Fig. 2-1).

Maximum Power Point Tracking Technology

Due to the nonlinear characteristics of solar array, there is a maximum energy output point (Max Power Point) on its curve. Traditional controllers, with switch charging technology and PWM charging technology, can't charge the battery at the maximum power point, so the maximum energy available cannot be harvested from the PV array, but the solar charge controller with Maximum Power Point Tracking (MPPT) Technology can lock on the point to harvest the maximum energy and deliver it to the battery.

Installation Instructions

General Installation Notes

**WARNING: Risk of Explosion**

Explosive battery gasses may be present during charging. Be certain there is sufficient ventilation.

**WARNING: Risk of Fire**

Loose power connections and/or corroded wires may result in resistive connections that melt wire insulation, burn surrounding materials, or even cause fire. Ensure tight connections and use cable clamps to secure cables and prevent them from swaying in mobile applications.

**WARNING: Risk of Electrocutation**

Use insulated tools and avoid placing metal objects near the batteries.

**CAUTION: Risk of Injury**

Exercise caution when working with batteries. Wear eye protection. Have fresh water available to wash and clean any contact with battery acid.

- » Use with sealed batteries only under the controller requirements.
- » Battery connection may be wired to one battery or a bank of batteries. The following instructions refer to a singular battery, but battery connections can be made to either one battery or a group of batteries in a battery bank.
- » Select the system cables according to $3A/mm^2$ current density.

Installation Instructions

PV Array Requirements

Serial Connection (String) of PV Modules

As the core component of PV system, the controller is suitable for various types of PV modules that can maximize the efficiency of converting solar energy into electrical energy. According to the open circuit voltage (V_{oc}) and the maximum power point voltage (V_{Mpp}) of the MPPT controller, the series number of different types of PV modules can be calculated. The following table is for reference only.

System Voltage	36 cell $V_{oc}<23V$		48 cell $V_{oc}<31V$		54 cell $V_{oc}<34V$		60 cell $V_{oc}<38V$	
	MAX.	Best	MAX.	Best	MAX.	Best	MAX.	Best
12V	4	2	2	1	2	1	2	1
24V	6	3	4	2	4	2	3	2

System Voltage	72 cell $V_{oc}<46V$		96 cell $V_{oc}<62V$		Thin-Film Module $V_{oc}>80V$
	MAX.	Best	MAX.	Best	
12V	2	1	1	1	1
24V	3	2	2	2	1

Table 3-1



NOTE

The above parameter values are calculated under standard test conditions (Irradiance @ $1000W/m^2$, Module Temperature @ $25^{\circ}C$, Air Mass @ 1.5)

PV Array Maximum Power

This MPPT controller has a limiting function on the charging current. The charging current will be limited within a rated range. The controller will charge the battery with the rated charging power even if the input power at the PV module exceeds the rate.

The actual operation power of the PV array conforms to the conditions below:

- » PV array actual power \leq controller rated charge power, the controller will charge the battery at the actual maximum power point.
- » PV array actual power $>$ controller rated charge power, the controller will charge the battery at the rated power.

If the PV array power is higher than rated power, the charging time at the rated power to the battery will be longer.



WARNING

The controller will be damaged if:

- » The PV array straight polarity and the actual operation power of the PV array is three times greater than the rated charge power.
- » The PV array reverse polarity and the actual operation power of the PV array is 1.5 times greater than the rated charge power.

Reference the table below for further information on Battery Charging Current:

Battery Charging Current				
Model	Rated Charge Current (I_{Bat})	Rated Charge Power	MAX. PV Power (P_{Max})	MAX. PV Open Circuit Voltage
FLEXmax30	30A	390W/12V, 780W/24V	1170W /12V 2340W / 24V	150V* 138V**
FLEXmax40	40A	520W/12V, 1040W/24V	1560W / 12V 3120W / 24V	

*At minimum operating environment temperature

**At 25°C environment temperature

Table 3-2

Installation Instructions

Wire Size

The wiring and installation methods must conform to all national and local electrical code requirements.

PV Wire Size

Since the PV outputs can vary due to the array connection method, the minimum wire size must be in accordance with the maximum array short-circuit current.

The minimum wire size can be calculated by the I_{sc} of the PV array. Refer to the value of I_{sc} in the PV module's manufacturer recommendation. When the PV modules connect in series, the I_{sc} is equal to the PV module's I_{sc} . When the PV modules connect in parallel, the I_{sc} is equal to the sum of the PV module's I_{sc} . The I_{sc} of the PV array must not exceed the maximum PV input current.

PV Wire Size		
Model	MAX. PV Input Current	MAX. PV Wire Size (mm2/AWG)
FLEXmax30	30A	10/8
FLEXmax40	40A	16/6

Table 3-3



CAUTION: Equipment Damage

When the PV modules connect in series, the open circuit voltage of the PV array must not exceed 138V (25°C)

Battery and Load Wire Size

The battery and load wire size must conform to the rated current. Reference sizes are listed below:

Battery and Load Wire Size				
Model	Rated Charge Current	Rated Discharge Current	Battery Wire Size (mm ² /AWG)	Load Wire Size (mm ² /AWG)
FLEXmax30	30A	20A	10/8	6/10
FLEXmax40	40A	20A	16/6	6/10

Table 3-4



NOTE

The wire size is only for reference. If there is a long distance between the PV array and the controller or between the controller and the battery, larger wires can be used to reduce the voltage drop and improve performance.

Installation Instructions

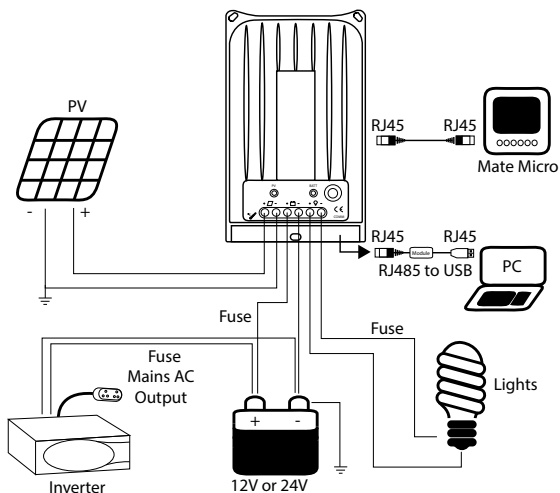

Fig. 3-1, Installation Overview

1. Connect components to the charge controller as shown in Fig. 3-1, noting the + (Red) and - (Black) connections.
2. After installation, power the battery and check the battery indicator on the controller, it will be green. If it's not green, refer to the "Protection, Troubleshooting and Maintenance" Section.
3. The battery fuse should be installed as close to the battery as possible. The suggested distance is within 150mm.
4. The FLEXmax series is a negative ground controller. Any negative connection of solar, load, or battery can be earth grounded as required.



NOTE

Unplugging the RTS will set the battery temperature to a fixed value of 25 °C.

Operation

MPPT Technology

The FLEXmax 30/40 series utilizes Maximum Power Point Tracking (MPPT) technology to extract maximum power from the solar module(s). The tracking algorithm is fully automatic and does not require user adjustment. The FLEXmax 30/40 series technology will track the Maximum Power Point Voltage (V_{mp}) as it varies with weather conditions, ensuring that maximum power is harvested from the array.

$$\text{Input Power (P}_{PV}\text{)} = \text{Output Power (P}_{Bat}\text{)}$$



$$\text{Input Voltage (V}_{MP}\text{)} * \text{Input Current (I}_{PV}\text{)} = \text{Battery Voltage (V}_{Bat}\text{)} * \text{Battery Current (I}_{Bat}\text{)}$$

Current Boost

In many cases, FLEXmax 30/40 series MPPT technology will “boost” the solar charge current, without creating current. For example, a system may have 8 Amps of solar current flowing into the FLEXmax 30/40 series and 10 Amps of charge current flowing out to the battery.

Compared to Traditional Controllers

Traditional controllers connect the solar module directly to the battery when recharging. This requires that the solar module operate in a voltage range that is below the module’s V_{mp} . In a 12V system for example, the battery voltage may range from 11-15Vdc but the module’s V_{mp} is typically around 16 or 17V. Fig. 4-1 shows a typical current VS. voltage output curve for a nominal 12V off-grid module.

The array V_{mp} is the voltage where the product of current and voltage (Amps×Volts) is greatest, which falls on the “knee” of the solar module I-V curve as shown in Fig. 4-1. Traditional controllers do not operate at the V_{mp} of the solar modules(s), resulting in wasted energy that could otherwise be used to charge the battery and power system loads. The greater the difference between battery voltage and the V_{mp} of the module, the more energy is wasted.

FLEXmax 30/40 series MPPT technology will always operate at the V_{mp} resulting in less wasted energy in comparison to traditional controllers.

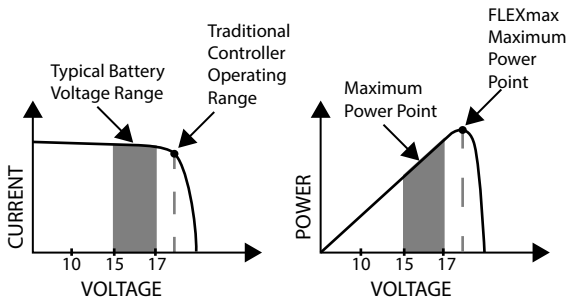

Fig. 4-1, Comparison to Traditional Controllers

Conditions Limiting the Effectiveness of MPPT

The V_{mp} of a solar module decreases as the temperature of the module increases. In extremely hot temperatures, the V_{mp} may be close to or even less than battery voltage. In this situation, there will be very little or no MPPT gain compared to traditional controllers. However, systems with modules of higher nominal voltage than the battery bank will always have an array V_{mp} greater than the battery voltage. Additionally, the savings in wiring due to reduced solar current make MPPT effective even in hot climates.

Battery Charging Information

Four Charging Stages

The FLEXmax 30/40 series utilizes a 4-stage battery charging algorithm for rapid, efficient, and safe battery charging.

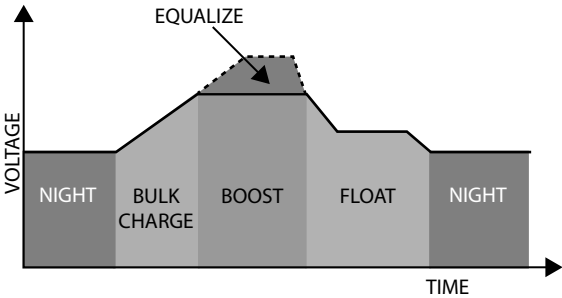

Fig. 4-2, MPPT Charging Algorithm

Bulk Charge

In this stage, the battery voltage uses 100% of the available solar power to recharge the battery.

Boost Charge

When the battery has recharged to the Boost Voltage point, constant voltage regulation is used to prevent heating and excessive battery gassing. The Boost Stage lasts for 120 minutes and then transitions to Float Charge. When the controller is powered on, if it does not detect over-discharge, nor overvoltage, the charging will enter into the Boost Charging stage.

Operation

Float Charge

After the Boost voltage stage, the FLEXmax 30/40 series will reduce the battery voltage to the Float voltage setpoint, charging with a smaller voltage and current. It will reduce the temperature of the battery and prevent gassing, while charging the battery at the same time. The purpose of the Float stage is to offset the power consumption caused by self consumption and small loads in the whole system, while maintaining full battery storage capacity. In Float stage, loads can continue to draw power from the battery. In the event that the system load(s) exceed the solar charge current, the controller will no longer be able to maintain the battery at the Float setpoint. Should the battery voltage remains below the boost reconnect charging voltage, the controller will exit Float stage and return to Bulk charging.

Equalization Charge



WARNING: Risk of Explosion

Equalizing a flooded battery can produce explosive gases. Ensure that the battery box is well-ventilated



CAUTION: Equipment Damage

Equalization may increase battery voltage to a level that can damage sensitive DC loads. Ensure that all allowable load input voltages are greater than the equalizing charging set point voltage.



CAUTION: Equipment Damage

Over charging and excessive gas precipitation may damage the battery plates and cause material shedding. Too high of an equalizing charge over an extended period of time may cause damage. Carefully review the specific requirements of the battery used in the system.

Certain types of batteries benefit from periodic equalized charging, which can stir the electrolytes, balancing the battery voltage and complete chemical reaction. Equalizing charge increases the battery voltage, higher than the standard complement voltage, which gasifies the battery electrolyte.

If it detects that the battery is being over discharged, the solar controller will automatically turn the battery to equalization charging stage, and the equalization charging will be 120mins. Equalizing charge and boost charge are not carried out constantly in a full charge process to avoid too much gas precipitation or overheating of the battery.



NOTE:

In the case of ambient circumstances or load and the battery cannot keep a constant voltage, the controller will accumulate and calculate the time of working constant voltage. When the accumulated time reaches 3 hours, the charging mode will turn to Float Charging.

If the controller time is not adjusted, the controller will equalize charge the battery once every month.

LED Indicators

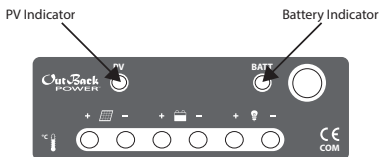

Fig. 4-3, LED Indicators



LED Indications			
LED Indication	Color	Display	Status
 PV Status LED Indicator	Green	On Solid	PV Available
	Green	Slowly Flashing	In Charging
	Green	OFF	No Charge
 Battery Status LED Indicator	Green	On Solid	Battery Connected
	Green	Slowly Flashing	Full
	Green	Fast Flashing	Over Voltage
	Orange	On Solid	Under Voltage
	Red	On Solid	Over Discharge
	Red	Flashing	Battery Overheating
Load Status LED Indicator	Red	On Solid	Load ON
	Red	OFF	Load OFF
	Red	Fast Flashing	Load Short Circuit
	Red	Slowly Flashing	Load Overload
Charging (green), battery (orange), and load (red) indicator flashing simultaneously			System Voltage Error
Charging (green) and battery indicator (orange) flashing simultaneously			Controller Overheating

Table 4-1

Configuring the Controller

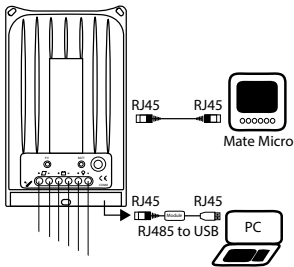

Fig. 4-4, Setting Operation

There are two methods available to configure the controller

1. Remote Meter, Mate Micro (Use a standard twisted net cable, model).
2. PC monitoring setting software OB Micro Series Monitor (Use a USB to RS485 converter cable as shown in Fig. 4-5, model: FM Micro Comm Cable).



WARNING:

Do not use the standard twisted net cable to connect the device and PC net interface. This will cause permanent damage.

Load Set Mode

- » Manual Control (Default)
- » Light ON/OFF
- » Light ON + Timer
- » Time Control

Battery Type

- » Gel
- » Sealed (Default)
- » Flooded
- » Use



NOTE:

Please refer to the user guide for configuring operation details.

Operation

The RJ45 interface is defined for the FLEXmax series controller below:

Rj45 Interface Pins	
Pins	Description
1	Power Supply Output +5V
2	Power Supply Output +5V
3	RS-485-B
4	RS-485-B
5	RS-485-A
6	RS-485-A
7	Ground
8	Ground

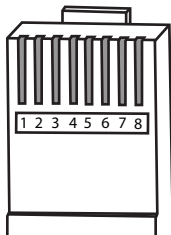

Fig. 4-5, RJ45 Defined Pins



CAUTION: Equipment Damage

The RJ45 interface is only compatible with OutBack Power products and must only be operated by qualified personnel. The RJ45 interface voltage is 5V and the current is 50mA.

Load Set Mode

Manual Control (default)

The load can be switched by the button on the FLEXmax controller or via remote control command.

Light On/Off

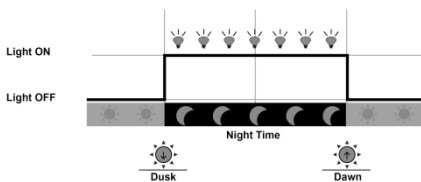

Fig. 4-6, Light On/Off

Light On+ Timer

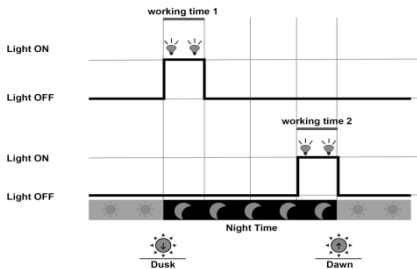

Fig. 4-7, Light On+ Timer

Time Control

This mode controls the load on/off time through a real-time clock setting.

Protection, Troubleshooting and Maintenance

Protection

» PV Array Short Circuit

When a PV short circuit occurs, the controller will stop charging. Clear it to resume normal operation.

» PV Overvoltage

If the PV voltage is larger than the maximum 150V input open voltage, the PV will remain disconnected and displaying a warning until the voltage falls safely below 145V. The PV voltage cannot be too high, otherwise it may damage the controller.

» PV Overcurrent

The FLEXmax 30/40 series controller will limit the battery charging current to the Maximum Battery Current rating. An over-sized solar array will not operate at peak power.

» Load Overload

If the load current exceeds the maximum load current rating 1.05 times, the controller will disconnect the load. Overloading must be cleared by reducing the load and restarting the controller.

» Load Short Circuit

If the load short circuits (at more than quadruple rate current), the load short circuit protection will start automatically. After five automatic load reconnect attempts, the fault must be cleared by restarting the controller.

» PV Reverse Polarity

The FLEXmax 30/40 Series is protected against PV reverse polarity. Correct the wiring to resume normal operation.



WARNING

The controller will be damaged if the PV array reverse polarity and the actual operation power of the PV array is 1.5 times greater than the rated charge power.

Protection, Troubleshooting and Maintenance

» Battery Reverse Polarity

The FLEXmax 30/40 Series is protected against battery reverse polarity. Correct the wiring to resume normal operation.

» Damaged Remote Temperature Sensor

If the temperature sensor is short-circuited or damaged, the controller will charge or discharge at the default temperature 25°C to prevent the battery from overcharging or over discharging.

» Over Temperature Protection

If the temperature of the controller heat sinks exceeds 85°C, the controller will automatically start overheating protection and recover below 75°C.

» Battery Overvoltage

When the battery voltage reaches a voltage set point of Overvoltage Disconnect, the controller will stop charging the battery to protect the battery from overcharging.

» Battery Overdischarge

When the battery voltage reaches a voltage set point of Low Voltage Disconnect, the controller will stop discharging the battery to protect the battery's service life.

» Battery Overheating

The controller detects the battery temperature through the external temperature sensor. If the battery temperature exceeds 65°C, the controller will automatically stop working and recover the battery once it reaches below 50°C.

Troubleshooting

Faults	Cause	Troubleshooting
Charging LED indicator off when PV Module is exposed to sunlight	PV array disconnection	Confirm that the PV and battery wire connections are correct and tight
Green Battery LED indicator is blinking	Battery voltage greater than over voltage disconnect	Check if the battery voltage is too high, and disconnect the solar module
Battery LED indicator is orange	Battery under voltage	Load output is normal, charging LED indicator will return to green automatically when fully charged
Battery LED indicator is red	Battery low voltage is disconnected	The controller cut off the output automatically, LED indicator will return to green when fully charged
All of the LED indicators are blinking (Orange)	Controller temperature is too high	When the heat sink of the controller exceeds 85°C, the controller will automatically cut the input and output circuit. When the temperature drops below 75°C, the controller will resume operation
All of the LED indicators are blinking (Red)	System voltage error	Change the controller to a suitable battery or reset the working voltage. Remove all faults and click the button to resume normal functioning.
No output load terminals	Over load or short circuit	Remove or reduce the load and click the button, the controller will resume to work after 3 seconds.

Table 5-1



NOTE:

If all of the LEDs are off, check the battery voltage. There must be at least 9V to activate the controller.



NOTE:

If the charging LED is steady OFF and it is not wired incorrectly, check the PV input voltage. PV input voltage should be higher than battery input voltage.

Maintenance



CAUTION: Risk of Electric Shock

Make sure all the power is turned off before performing the operations below.

Perform the following inspections and maintenance tasks at least two times per year ensure the best performance.

- » Check that the controller is securely mounted in a clean and dry environment.
- » Check that the air flow and ventilation around the controller is not blocked. Clear all dirt or fragments on the heat sink.
- » Check all the naked wires to make sure insulation is not damaged for serious solarization, frictional wear, dryness, insects or rats etc. Maintain or replace the wires if necessary.
- » Tighten all the terminals. Inspect for loose, broken, or burnt wire connections.
- » Confirm that all the system components are ground connected tightly and correctly.
- » Confirm that all the terminals have no corrosion, insulation damaged, high temperature or burnt/discolored sign, tighten terminal screws to the suggested torque.
- » Inspect for dirt, insects and corrosion, and clear up.
- » Check and confirm that lightning arrester is in good condition. Replace immediately if any condition might hinder performance to avoid possible lightning damage to the controller or other system components.

Technical Specifications

Technical Specifications

Electrical Parameters

Description	Parameter
Nominal System Voltage	12VDC / 24VDC Auto Work
Rated Charge Current	FLEXmax 30 - 30A FLEXmax 40 - 40A
Rated Discharge Current	FLEXmax 30 - 20A FLEXmax 40 - 20A
Battery Voltage Range	8V - 32V
Maximum PV Open Circuit Voltage	150VDC (at minimum operating environment temperature) 138V (at 25°C)
MPP Voltage Range	Battery Voltage +2V - 108V
Maximum PV Input Power	FLEXmax 30 - 390W (12V) / 780W (24V) FLEXmax 40 - 520W (12V) / 1040W (24V)
Self-Consumption	≤60mA (12V) / ≤30mA (24V)
Discharge Circuit Voltage Drop	≤0.15V
Temperature Compensate Coefficient	-3mV/°C/2V (Default)
Communication	RS485 (RJ45 Interface)
Grounding	Common negative

Table 6-1



NOTE:

Battery Voltage Parameters are for a 12V system at 25°C; use twice the value in 24V systems.

Control Parameters

Battery Charging Set	Gel	Sealed	Flooded	User
Over Voltage Disconnect Voltage	16.0V	16.0V	16.0V	9~17V
Charging Limit Voltage	15.0V	15.0V	15.0V	9~17V
Over Voltage Reconnect Voltage	15.0V	15.0V	15.0V	9~17V
Equalize Charging Voltage	-	14.6V	14.8V	9~7V
Boost Charging Voltage	14.2V	14.4V	14.6V	9~17V
Float Charging Voltage	13.8V	13.8V	13.8V	9~17V
Boost Reconnect Charging Voltage	13.2V	13.2V	13.2V	9~17V
Low Voltage Reconnect Voltage	12.6V	12.6V	12.6V	9~17V
Under Voltage Warning Reconnect Voltage	12.2V	12.2V	12.2V	9~17V
Under Voltage Warning Voltage	12.0V	12.0V	12.0V	9~17V
Low Voltage Disconnect Voltage	11.1V	11.1V	11.1V	9~17V
Discharging Limit Voltage	10.6V	10.6V	10.6V	9~17V
Equalize Duration	-	2 hours	2 hours	0 ~ 3 hours
Boost Duration	2 hours	2 hours	2 hours	0 ~ 3 hours

Table 6-2

Technical Specifications



NOTE:

User type is the user defined battery type. The default value is the same as the sealed type. When modifying the default value, follow the logistic relation:

- » Over Voltage Disconnect Voltage > Charging Limit Voltage \geq Equalize Charging Voltage \geq Boost Charging Voltage \geq Float Charging Voltage > Boost Reconnect Charging Voltage.
- » Over Voltage Disconnect Voltage > Over Voltage Reconnect Voltage.
- » Low Voltage Reconnect Voltage > Low Voltage Disconnect Voltage \geq Discharging Limit Voltage.
- » Under Voltage Warning Reconnect Voltage > Under Voltage Warning Voltage \geq Discharging Limit Voltage.
- » Boost Reconnect Charging voltage > Low Voltage Disconnect Voltage.

Environmental Parameters

Environmental	Parameter
Ambient Temperature Range	-35°C to +55°C
Storage Temperature Range	-35°C +80°C
Humidity Range	$\leq 95\%$ (NC)
Enclosure	IP30
Altitude	$\leq 3000\text{m}$

Table 6-3

Mechanical Parameters

FLEXmax Model	Dimensions	Mounting Dimensions	Hole Size	Power Cable	Weight
FLEXmax 30	280.7mm x 159.7mm x 60mm	Detail in Dimensions Drawing	$\phi 4.7$	16mm ²	2.3kg
FLEXmax 40	302.5mm x 182.7mm x 63.5mm	Detail in Dimensions Drawing	$\phi 4.7$	25mm ²	2.9kg

Table 6-4

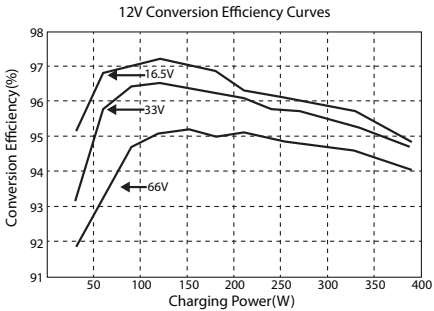

Fig. 6-1, FLEXmax 30 12V Conversion Efficiency Curves

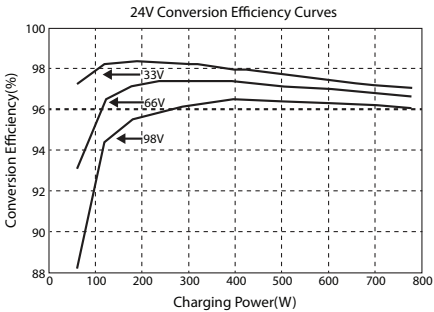

Fig. 6-2, FLEXmax 30 24V Conversion Efficiency Curves

Technical Specifications

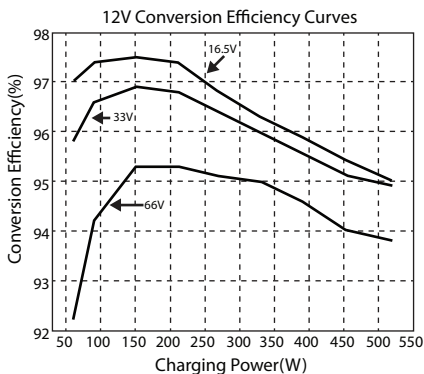

Fig. 6-3, FLEXmax 40 12V Conversion Efficiency Curves

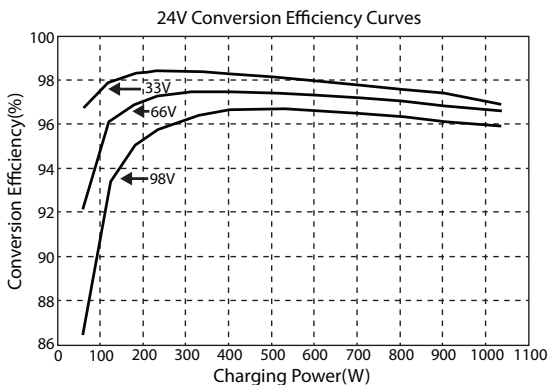

Fig. 6-4, FLEXmax 40 24V Conversion Efficiency Curves

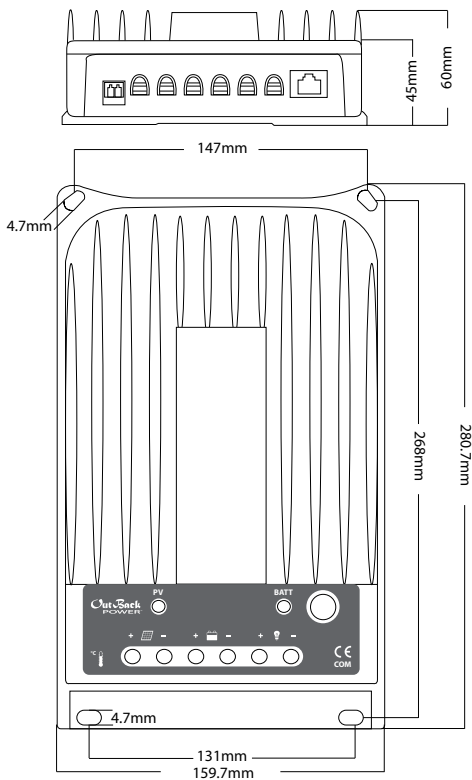

Fig. 6-5, FLEXmax 30 Dimensions

Technical Specifications

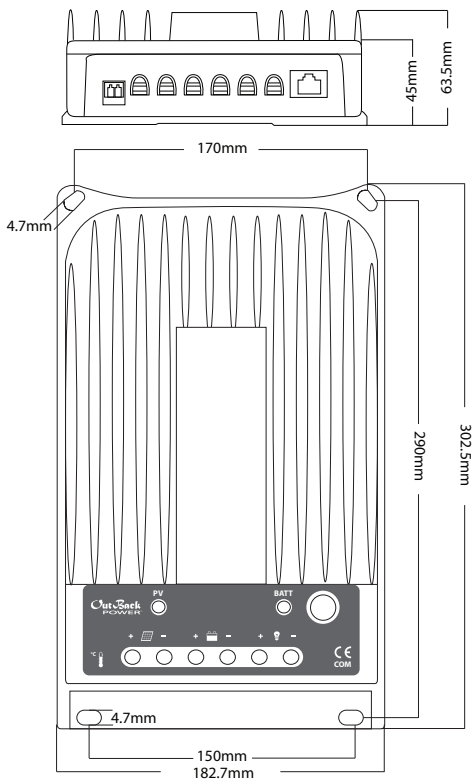

Fig. 6-6, FLEXmax 40 Dimensions



Outback Power - Europe
Hansastraße 8
D-91126
Schwabach, Germany
Tel: +49 (0)9122 79889-0