

CLASSIC POSTS

OUR COLLECTION

CLASSIC lighting poles of a single piece without joints, made of shockproof composite material (steel-expanse-resin), UV-rays stabilized, rust and corrosion-free. Moulded colours in paste, no maintenance or painting required. Insulation class II. Available in many design options and different sizes from 0,7mt up to 5mt high. Provided with suitable cage for ground fixation.

Pali in stile CLASSICO fabbricati in un unico pezzo senza giunzioni. Realizzati in materiale composito antiurto (ferro-resina-poliuretano), stabilizzato ai raggi UV, inattaccabile da ruggine e corrosione. Colore stampato in pasta, non necessita di verniciatura. Classe di isolamento II. Disponibili in numerose varianti decorative e in diverse altezze da mt. 0,7 a mt. 5. Provvisti di gabbia per il fissaggio a terra.



MADE IN
ITALY

METAL POST COVERED BY RESIN

Fumagalli **created** and developed a unique post technology, registered as **FUMATECH**. Fumatech technology grants to our lamps the same strength features of a metal post, combined with all the advantages in terms of rust and corrosion resistance that only a resin material can offer.

L'azienda Fumagalli ha **creato** e sviluppato un'esclusiva tecnologia per la fabbricazione dei pali, registrata come **FUMATECH**. La tecnologia FUMATECH assicura alle nostre lampade le medesime caratteristiche di solidità di un palo in metallo, con tutti i vantaggi in termini di resistenza alla ruggine e alla corrosione che solo la resina può offrire.



more details
at Pag. 16



INNER METAL POLE STRUCTURE

Structural metal pole hot deep galvanized inside and outside by zinc bath immersion.

Palo strutturale in metallo galvanizzato a caldo sia all'interno che all'esterno tramite immersione in bagno di zinco.

EXPANSE

High Density rigid polyurethane provides lightweight and durable cohesion between the inner metal post and the outer resin cover.

Il poliuretano ad alta densità. Rigido ma molto leggero, garantisce una coesione duratura nel tempo tra il palo interno in metallo e la copertura esterna in resina.

OUTER RESIN COVER

Outer coating of a single piece without joints made of shockproof resin material:

- Rust and corrosion-free
- Paste molded colors, UV stabilized
- Self-extinguishing on fire

Rivestimento esterno in un unico pezzo fabbricato in resina antiurto:

- Inattaccabile da ruggine e corrosione
- Colori in pasta stabilizzati ai raggi UV
- Autoestinguente al fuoco

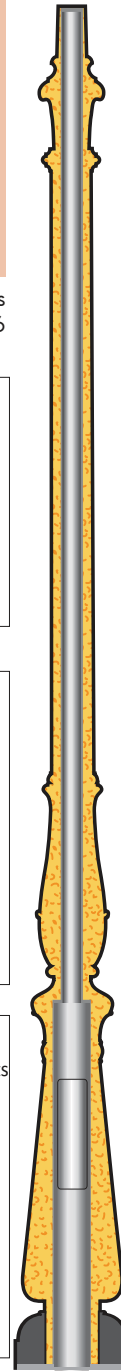

ANTI CORROSION



NO MAINTENANCE

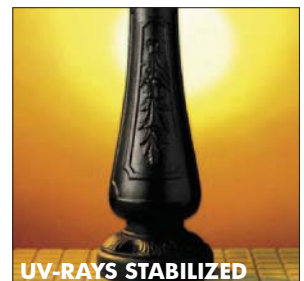

UV-RAYS STABILIZED



SAFE



UNAFFECTED BY CHEMICAL FERTILIZES

FULLY MODULAR



All the connection hubs of FUMAGALLI poles and lanterns have a diameter of 60 mm; this unique feature allows many different possible combinations of complete lamps with the same components, for a big stock flexibility.

POST COLOURS

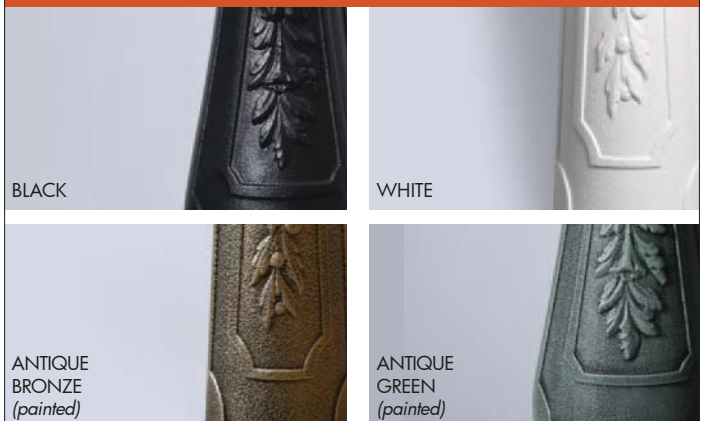

CLASSIC POSTS

INSPECTION DOORS

BULKHEAD
FLOODLIGHT
IN-GROUND
BRICKLIGHT
BOLLARDS
GARDEN
URBAN CLASSIC
URBAN MODERN
HIGH-BAY
POST
LAMPS

for KARMEI posts

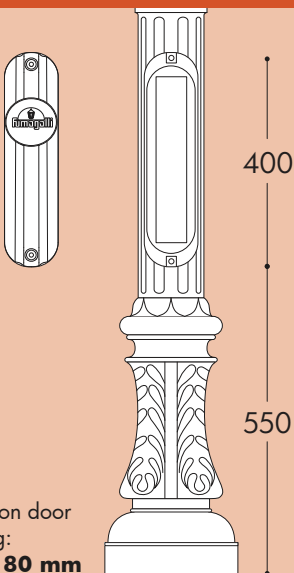
Inspection door opening:
340 x 80 mm



The inspection door can be personalized with your own logo (available only for KARMEI posts)

La porta di ispezione può essere personalizzata con il vostro LOGO (disponibile solo per i pali KARMEI)

for NEBO TABOR HOREB posts

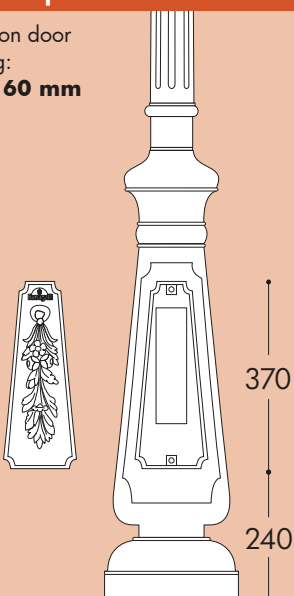



Inspection door opening:
320 x 60 mm

Duble Insulation
4 x 16 mm²
3 - WAY

CLASS II **IP44**

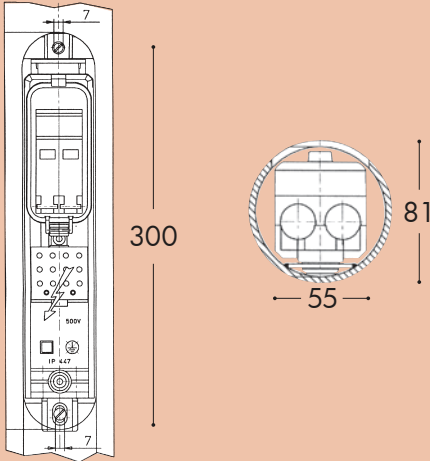
Fuse holder lfo electric cc.10



for GIONA posts



Inspection door opening:
185 x 80 mm

VERY EASY MAINTENANCE: IT'S ENOUGHW TO CLEAN THE POST WITH SOME OIL TO KEEP IT AS BRIGHT AS NEW.



CLASSIC POST - FOUNDATION SYSTEM



SUGGESTED SIZES FOR CONCRETE FOUNDATION

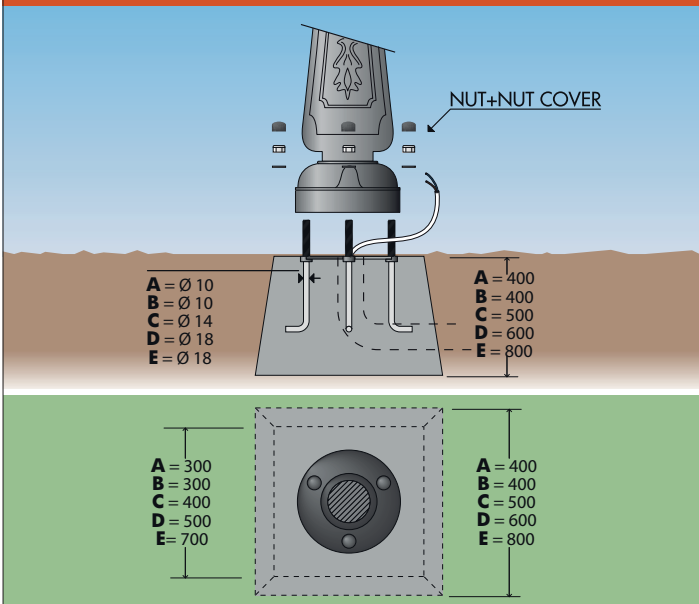

All Fumagalli poles are supplied with suitable cages for fixing into concrete foundations. The size of the cages and the size of the concrete foundation varies according to the high of the post.

Tutti i pali Fumagalli sono forniti complete di gabbie per il fissaggio a terra. Le dimensioni della gabbia e del plinto di cemento variano a secondo dell'altezza del palo.

The fixation system with two triangles allows the anchor bolts to be cemented perpendicularly to the ground. The second triangle has to be removed before installing the pole.

Il sistema di fissaggio con due triangoli assicura che i tiranti vengano affogati nel cemento in maniera perfettamente perpendicolare rispetto al terreno. Il secondo triangolo deve essere rimosso prima di procedere al fissaggio del palo.

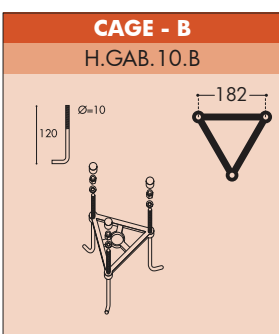
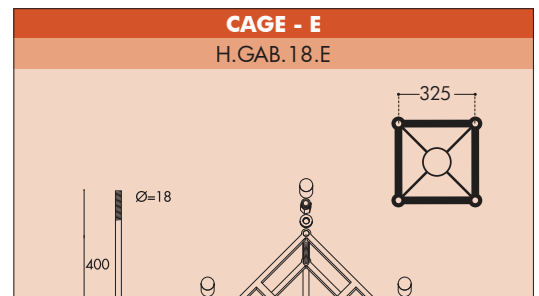
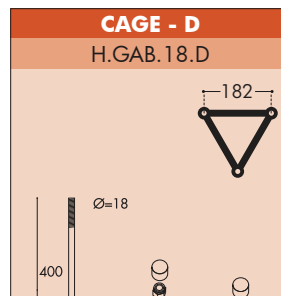
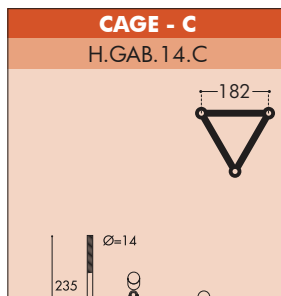
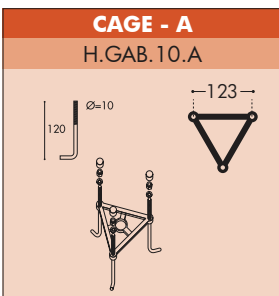

CLASSIC POSTS

CLASSIC POST COLLECTION

Each post is supplied with the suitable cage or screws for fixation.

Colours available for the CLASSIC range are the following:

Moulded colours: **Black - White**

Painted Colours: **Antique Green - Antique Bronze**

WITHOUT DOOR
WITH DOOR
WITH DOOR AND BOX

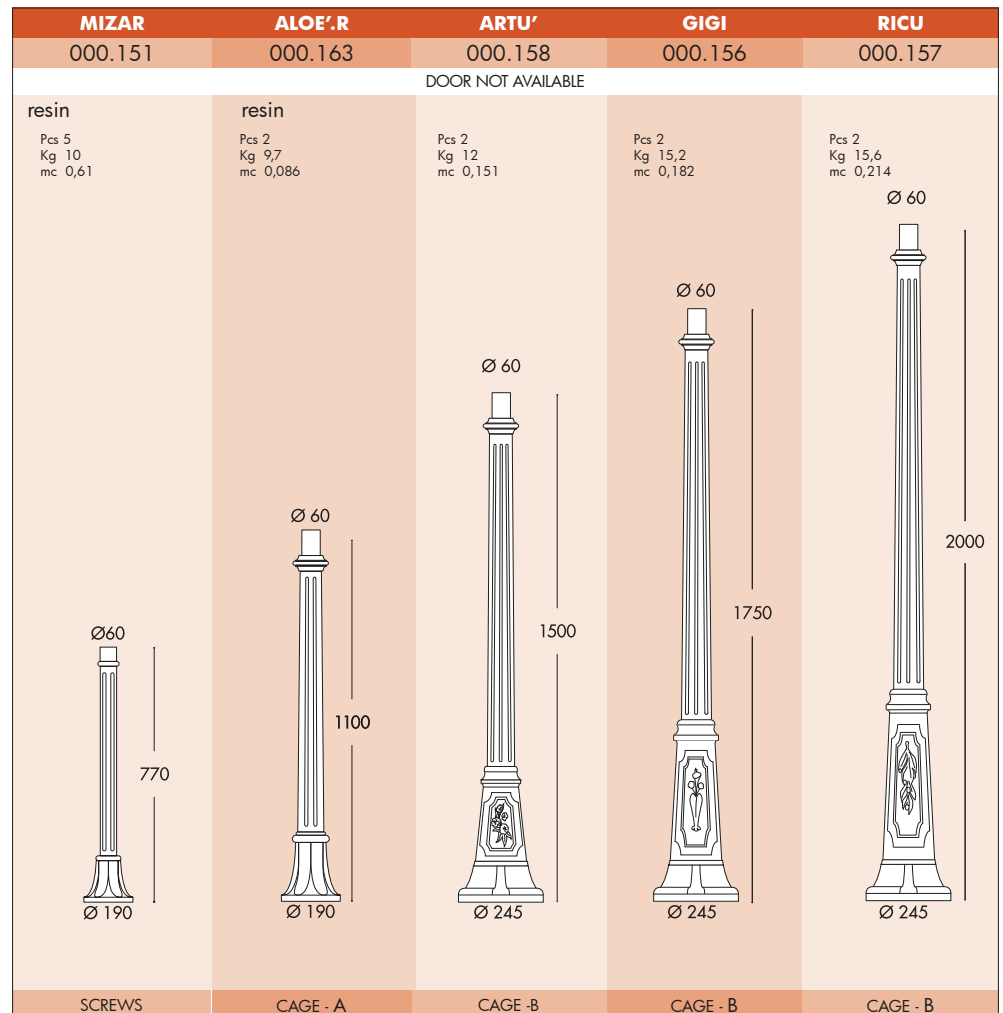
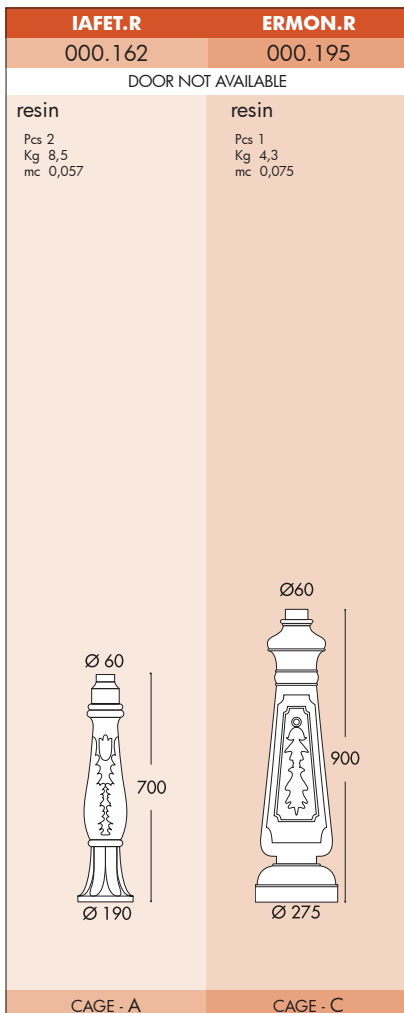
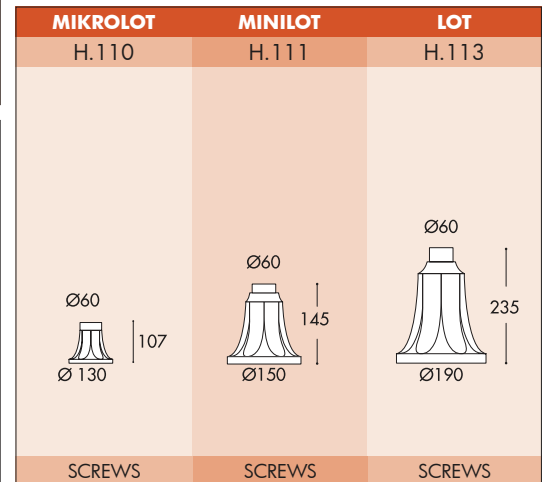
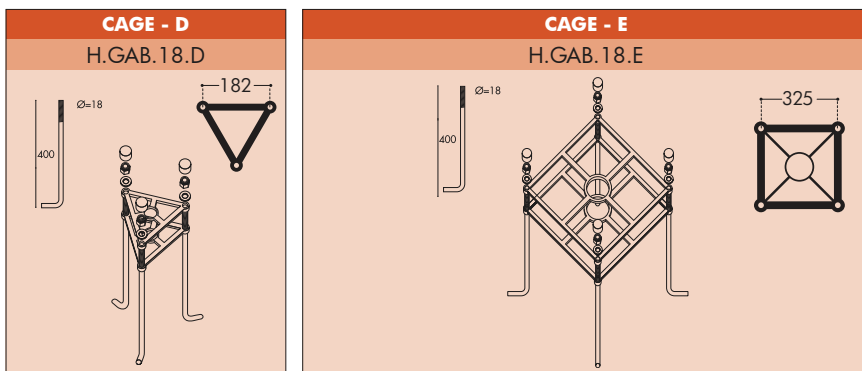
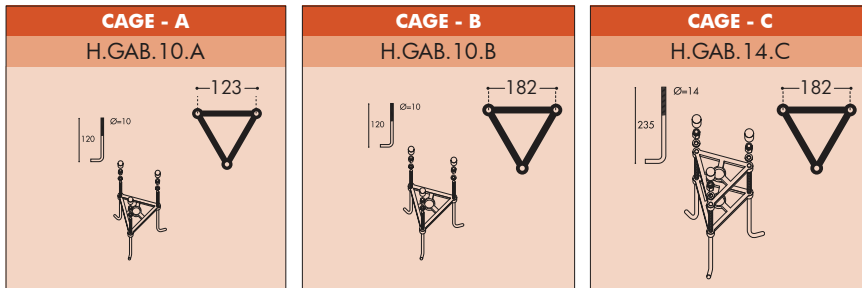

NEBO			TABOR			HOREB			KARMEL 3000			KARMEL 3500			KARMEL 4000			GIONA 4000			GIONA 4500			GIONA 5000		
000.201	000.204	000.207	000.201	000.204	000.207	000.201	000.204	000.207	000.231	000.234	000.237	000.231	000.234	000.237	000.231	000.234	000.237	000.221	000.224	000.227	000.221	000.224	000.227	000.221	000.224	000.227
000.202	000.205	000.208	000.202	000.205	000.208	000.202	000.205	000.208	000.232	000.235	000.238	000.232	000.235	000.238	000.232	000.235	000.238	000.222	000.225	000.228	000.222	000.225	000.228	000.222	000.225	000.228
000.203	000.206	000.209	000.203	000.206	000.209	000.203	000.206	000.209	000.233	000.236	000.239	000.233	000.236	000.239	000.233	000.236	000.239	000.223	000.226	000.229	000.223	000.226	000.229	000.223	000.226	000.229
DOOR IS OPTIONAL									DOOR IS OPTIONAL									DOOR IS OPTIONAL								
Pcs 1 Kg 22 mc 0,135	Pcs 1 Kg 25,5 mc 0,164	Pcs 1 Kg 29 mc 0,190	Pcs 1 Kg 23,5 mc 0,167	Pcs 1 Kg 25 mc 0,193	Pcs 1 Kg 28,5 mc 0,220	Pcs 1 Kg 51 mc 0,744	Pcs 1 Kg 54 mc 0,871	Pcs 1 Kg 57 mc 0,968																		
Ø 275	Ø 275	Ø 275	Ø 275	Ø 275	Ø 275	Ø 275	Ø 275	Ø 275	Ø 275	Ø 275	Ø 275	Ø 275	Ø 275	Ø 275	Ø 275	Ø 275	Ø 275	Ø 275	Ø 275	Ø 275	Ø 275	Ø 275	Ø 275	Ø 275	Ø 275	Ø 275
CAGE - C	CAGE - C	CAGE - C	CAGE - C	CAGE - C	CAGE - C	CAGE - C	CAGE - C	CAGE - D	CAGE - E	CAGE - E	CAGE - E	CAGE - E	CAGE - E	CAGE - E	CAGE - E	CAGE - E	CAGE - E	CAGE - E	CAGE - E	CAGE - E	CAGE - E	CAGE - E	CAGE - E	CAGE - E	CAGE - E	CAGE - E

BULKHEAD
FLOODLIGHT
IN-GROUND
BRICKLIGHT
BOLLARDS
GARDEN
URBAN CLASSIC
URBAN MODERN
HIGH-BAY
POST
LAMPS

CLASSIC POSTS

CLASSIC POST TOP SYSTEMS



FULLY MODULAR

All the connection hubs of FUMAGALLI poles and lanterns have a diameter of 60 mm; this unique feature allows many different possible combinations of complete lamps with the same components, for a big stock flexibility.

I terminali di connessione dei pali e delle lanterne FUMAGALLI hanno sempre un diametro di 60 mm; questa caratteristica unica permette svariate combinazioni di lampade complete con i medesimi componenti per una grande flessibilità di magazzino.

BISSO SYSTEM

BISSO SYSTEM 2L 000.000.S20	BISSO SYSTEM 2 + 1 000.000.S21	BISSO SYSTEM 3L 000.000.S30	BISSO SYSTEM 3 + 1 000.000.S31

OFIR SYSTEM



















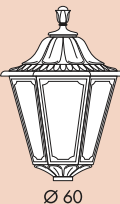





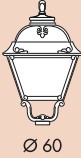

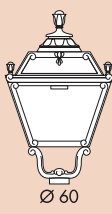

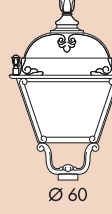

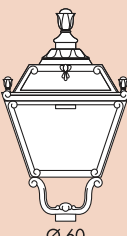





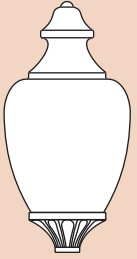

OFIR SYSTEM 2L 000.000.R20	OFIR SYSTEM 2 + 1 000.000.R21	OFIR SYSTEM 3L 000.000.R30	OFIR SYSTEM 3 + 1 000.000.R31

ADAM SYSTEM

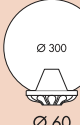
ADAM SYSTEM 2L 000.000.M20	ADAM SYSTEM 2 + 1 000.000.M21	ADAM SYSTEM 3L 000.000.M30	ADAM SYSTEM 3 + 1 000.000.M31

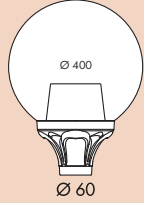
ARON SYSTEM

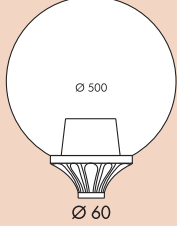
ARON SYSTEM 1L 000.000.N10	ARON SYSTEM 2L 000.000.N20	ARON SYSTEM 4L 000.000.N40

	SMALL SIZE	MEDIUM SIZE	LARGE SIZE	GRAND SIZE				
HEXAGONAL LANTERNS	ANNA E22.000  220 Ø 60  220	SABA K22.000  220 Ø 60  260	RUT E26.000  260 Ø 60  260	SALEM K26.000  260 Ø 60  350	NOEMI E35.000  350 Ø 60  350	SILOE K35.000  350 Ø 60  350		
	SQUARE LANTERNS		GOLIA Q23.000  230 Ø 60  230	CEFA U23.000  230 Ø 60  230	TOBIA Q33.000  330 Ø 60 * FLAT DIFFUSER  330	SIMON U33.000  330 Ø 60 * FLAT DIFFUSER  330	ELIA Q43.000  430 Ø 60 * FLAT DIFFUSER  430	PIETRO U43.000  430 Ø 60 * FLAT DIFFUSER  430
HALF LANTERNS		IESSE M22.000  130 350  220			DARIA M28.000  143 515  280	CANA 500 C50.B50  690  Ø400		
	GLOBES	GLOBE 250 CLASSIC G25.B25  260 Ø 250 Ø 60  Ø250	GLOBE 300 CLASSIC G30.B30  310 Ø 300 Ø 60  Ø300	GLOBE 400 CLASSIC G40.B40  Ø 400 530 Ø 60  Ø400	GLOBE 500 CLASSIC G50.B50  Ø 500 630 Ø 60  Ø500			

BULKHEAD
FLOODLIGHT
IN-GROUND
BRICKLIGHT
BOLLARDS
GARDEN
URBAN CLASSIC
URBAN MODERN
HIGH-BAY
POST
LAMPS